

Coaxlink

Coaxlink 12.4.0 Release Notes

1629 Coaxlink Duo PCIe/104-EMB

1630 Coaxlink Mono

1631 Coaxlink Duo

1632 Coaxlink Quad

1633 Coaxlink Quad G3

1633-LH Coaxlink Quad G3 LH

1634 Coaxlink Duo PCIe/104-MIL

1635 Coaxlink Quad G3 DF

1637 Coaxlink Quad 3D-LLE

3602 Coaxlink Octo

3603 Coaxlink Quad CXP-12

3620 Coaxlink Quad CXP-12 JPEG

3621-LH Coaxlink Mono CXP-12 LH

3622 Coaxlink Duo CXP-12

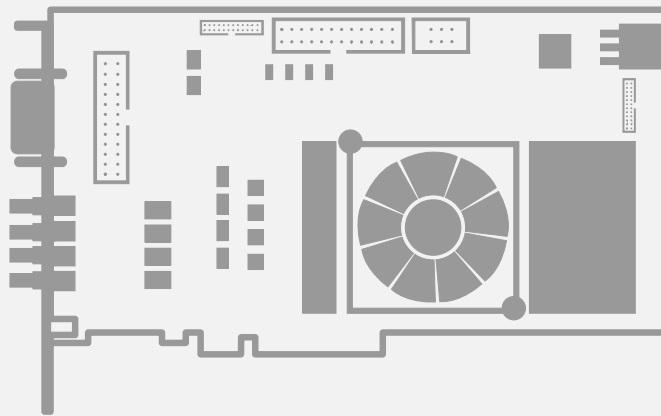

Terms of Use

EURESYS s.a. shall retain all property rights, title and interest of the documentation of the hardware and the software, and of the trademarks of EURESYS s.a.

All the names of companies and products mentioned in the documentation may be the trademarks of their respective owners.

The licensing, use, leasing, loaning, translation, reproduction, copying or modification of the hardware or the software, brands or documentation of EURESYS s.a. contained in this book, is not allowed without prior notice.

EURESYS s.a. may modify the product specification or change the information given in this documentation at any time, at its discretion, and without prior notice.

EURESYS s.a. shall not be liable for any loss of or damage to revenues, profits, goodwill, data, information systems or other special, incidental, indirect, consequential or punitive damages of any kind arising in connection with the use of the hardware or the software of EURESYS s.a. or resulting of omissions or errors in this documentation.

This documentation is provided with Coaxlink 12.4.0 (doc build 2106).
www.euresys.com

Contents

1. Release Benefits	4
2. Release Specification	6
2.1. Products & Accessories	7
2.2. Firmware Variants per Product	8
2.3. CoaXPress Standard Compliance	14
2.4. Supported Operating Systems	15
2.5. Memento	16
2.6. Development Tools	17
2.7. Software Tools	17
3. Important Notices	18
3.1. Firmware Version Requirements	19
3.2. CPU Requirements	20
3.3. Driver Installation on macOS	21
3.4. Driver Installation on Windows	22
3.5. Driver Installation on Windows 7	24
3.6. Driver Installation on Windows Server 2016	25
3.7. Flash EEPROM Change Note	26
4. Release Details	28
4.1. Products Support Changes	29
4.2. Firmware Variants Support Changes	30
4.3. Added/Improved Features	31
4.4. Breaking Changes	33
5. Known Issues	42
5.1. Deviations from the CoaXPress specification	43
Host Connections Maps	43
5.2. Deviations from the GenTL specification	50
5.3. Deviations from the PCIe 3.0 specification	52
5.4. Functional Limitations	53
aarch64 ARM Processor Architecture	53

1. Release Benefits

Coaxlink 12.4

New CXP-12 CoaXPress frame grabbers

This release adds the support for **3621-LH Coaxlink Mono CXP-12 LH** and **3622 Coaxlink Duo CXP-12**, two compact frame grabbers fitted with, respectively, one- and two- connection CXP-12 CoaXPress interfaces.

The CXP-12 CoaXPress front-end operates at any CoaXPress link speed ranging from CXP-1 up to CXP-12. It extends the cable range up to 70 m when it operates at CXP-6 speed and provides a comfortable 40 m cable range when it operates at CXP-12. The Micro-BNC (also known as HD-BNC™) connector type provides a robust bayonet locking mechanism largely adopted by the video broadcast industry.

The compact form factor enables the installation in standard-profile and low-profile PCI Express enclosures.

Firmware variant for **3621-LH Coaxlink Mono CXP-12 LH**

This release of Coaxlink adds the "1-camera" firmware variant for **3621-LH Coaxlink Mono CXP-12 LH**.

It allows connecting one 1-connection area-scan camera.

Firmware variants for **3622 Coaxlink Duo CXP-12**

This release of Coaxlink adds the "1-camera" and the "2-camera" firmware variants for **3622 Coaxlink Duo CXP-12**.

The "1-camera" firmware variant allows connecting one 1- or 2-connection area-scan camera. The "2-camera" firmware variant allows connecting one or two 1-connection area-scan cameras.

CoaXPress 2.0 error counters

This release of Coaxlink adds a set of counters to keep track of various errors that the CoaXPress protocol can detect.

This feature allows the user to monitor the quality of the CoaXPress link and identify weaknesses of each CoaXPress connection.

PCI Express performance evaluation tool

This release of Coaxlink adds a tool to measure the effective data transfer rate from the Coaxlink on-board frame store to system memory.









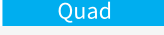
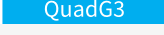

This tool allows the user to assess the performance of the PCI Express interface in the actual host PC.

2. Release Specification

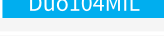
2.1. Products & Accessories	7
2.2. Firmware Variants per Product	8
2.3. CoaXPress Standard Compliance	14
2.4. Supported Operating Systems	15
2.5. Memento	16
2.6. Development Tools	17
2.7. Software Tools	17

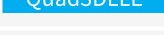
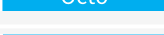
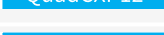
2.1. Products & Accessories

Coaxlink main products

Product	S/N Prefix	Icon
1630 Coaxlink Mono	KMO	
1631 Coaxlink Duo	KDU	
1632 Coaxlink Quad	KQU	
1633 Coaxlink Quad G3	KQG	
1633-LH Coaxlink Quad G3 LH	KQH	
1629 Coaxlink Duo PCIe/104-EMB	KDI	
1634 Coaxlink Duo PCIe/104-MIL	KDR	
1635 Coaxlink Quad G3 DF	KDF	
1637 Coaxlink Quad 3D-LLE	KQE	
3602 Coaxlink Octo	KOC	
3603 Coaxlink Quad CXP-12	KQP	
3620 Coaxlink Quad CXP-12 JPEG	KQJ	
3621-LH Coaxlink Mono CXP-12 LH	KMP	
3622 Coaxlink Duo CXP-12	KDP	

- The *S/N prefix* is a 3-letter string at the beginning of the card serial number.
- *Icons* are used in this document for tagging titles of card-specific content.

Related accessory products

Product	S/N Prefix	Icon
1625 DB25F I/O Adapter Cable	DBC	1625
1636 InterPC C2C-Link Adapter	KCC	1636
3300 HD26F I/O module for Coaxlink Duo PCIe/104	KDM	3300
3301 Thermal drain (Model 1) for Coaxlink Duo PCIe/104		3301
3302 DIN1.0/2.3 Coaxial cable for Coaxlink Duo PCIe/104		3302
3303 C2C-Link Ribbon Cable		3303
3304 HD26F I/O Adapter Cable		3304
3610 HD26F I/O Extension Module TTL-RS422	EMA	3610
3612 HD26F I/O Extension Module TTL-CMOS5V-RS422	EMC	3612
3614 HD26F I/O Extension Module - Standard I/O Set	EMD	3614

2.2. Firmware Variants per Product

1630 Coaxlink Mono

Firmware Variant	Description	Host Connections Map	Advanced Processing
1-camera	One 1-connection area-scan camera	1D1	LUT

1631 Coaxlink Duo

Firmware Variant	Description	Host Connections Map	Advanced Processing
1-camera	One 1- or 2-connection area-scan camera	1D2	LUT
1-camera, line-scan	One 1- or 2-connection line-scan camera	1D2	LUT
2-camera	One or two 1-connection area-scan cameras	2D11	LUT
2-camera, line-scan	One or two 1-connection line-scan cameras	2D11	LUT

1632 Coaxlink Quad

Firmware Variant	Description	Host Connections Map	Advanced Processing
1-camera	One 1- or 2- or 4-connection area-scan camera	1D4	LUT
1-camera, line-scan	One 1- or 2- or 4-connection line-scan camera	1D4	LUT
2-camera	One or two 1- or 2-connection area-scan cameras	2D22	LUT

1633 Coaxlink Quad G3

Firmware Variant	Description	Host Connections Map	Advanced Processing
1-camera	One 1- or 2- or 4-connection area-scan camera	1D4	FFC LUT CFA
1-camera, line-scan	One 1- or 2- or 4-connection line-scan camera	1D4	FFC LUT
1-slm-camera	Master 4-connection sub-link of an 8-connection 8-connection area-scan camera	1D8SLM4	LUT
1-sls-camera	Slave 4-connection sub-link of an 8-connection 8-connection area-scan camera	1D8SLS4	LUT
2-camera	One or two 1- or 2-connection area-scan cameras	2D22	LUT
2-camera, line-scan	One or two 1- or 2-connection line-scan cameras	2D22	LUT
3-camera	One 1- or 2-connection and one or two 1-connection area-scan cameras	3D211	LUT
4-camera	One or two or three or four 1-connection area-scan cameras	4D1111	LUT
4-camera, line-scan	One or two or three or four 1-connection line-scan cameras	4D1111	LUT
1-camera, 4-data-stream	One 1- or 2- or 4-connection area-scan camera, up to 4 data streams	1D4S4	-

1633-LH Coaxlink Quad G3 LH

Firmware Variant	Description	Host Connections Map	Advanced Processing
1-camera	One 1- or 2- or 4-connection area-scan camera	1D4	FFC LUT CFA
1-camera, line-scan	One 1- or 2- or 4-connection line-scan camera	1D4	FFC LUT
1-slm-camera	Master 4-connection sub-link of an 8-connection 8-connection area-scan camera	1D8SLM4	LUT
1-sls-camera	Slave 4-connection sub-link of an 8-connection 8-connection area-scan camera	1D8SLS4	LUT
2-camera	One or two 1- or 2-connection area-scan cameras	2D22	LUT
2-camera, line-scan	One or two 1- or 2-connection line-scan cameras	2D22	LUT
3-camera	One 1- or 2-connection and one or two 1-connection area-scan cameras	3D211	LUT
4-camera	One or two or three or four 1-connection area-scan cameras	4D1111	LUT
4-camera, line-scan	One or two or three or four 1-connection line-scan cameras	4D1111	LUT
1-camera, 4-data-stream	One 1- or 2- or 4-connection area-scan camera, up to 4 data streams	1D4S4	-

1629 Coaxlink Duo PCIe/104-EMB

Firmware Variant	Description	Host Connections Map	Advanced Processing
1-camera	One 1- or 2-connection area-scan camera	1D2	LUT
1-camera, line-scan	One 1- or 2-connection line-scan camera	1D2	LUT
2-camera	One or two 1-connection area-scan cameras	2D11	LUT

1634 Coaxlink Duo PCIe/104-MIL

Firmware Variant	Description	Host Connections Map	Advanced Processing
1-camera	One 1- or 2-connection area-scan camera	1D2	LUT
1-camera, line-scan	One 1- or 2-connection line-scan camera	1D2	LUT
2-camera	One or two 1-connection area-scan cameras	2D11	LUT

1635 Coaxlink Quad G3 DF

Firmware Variant	Description	Host Connections Map	Advanced Processing
1-camera	One 1- or 2- or 4-connection area-scan camera	1D4	LUT CFA
1-df-camera	One 1- or 2- or 4-connection area-scan data-forwarded camera	1DF4	LUT CFA
1-camera, line-scan	One 1- or 2- or 4-connection line-scan camera	1D4	FFC LUT
1-df-camera, line-scan	One 1- or 2- or 4-connection line-scan data-forwarded camera	1DF4	FFC LUT

1637 Coaxlink Quad 3D-LLE

Firmware Variant	Description	Host Connections Map	Advanced Processing
1-camera	One 1- or 2- or 4-connection area-scan camera	1D4	LLE

3602 Coaxlink Octo

Firmware Variant	Description	Host Connections Map	Advanced Processing
1-camera	One 1- or 2- or 4- or 8-connection area-scan camera	1D8	LUT CFA
1-camera, line-scan	One 1- or 2- or 4- or 8-connection line-scan camera	1D8	LUT
2-camera	One or two 1- or 2- or 4-connection area-scan cameras	2D44	FFC LUT CFA
2-camera, line-scan	One or two 1- or 2- or 4-connection line-scan cameras	2D44	LUT
4-camera	One or two or three or four 1- or 2-connection area-scan cameras	4D2222	LUT
4-camera, line-scan	One or two or three or four 1- or 2-connection line-scan cameras	4D2222	LUT
5-camera	One 1- or 2- or 4-connection and one or two or three or four 1-connection area-scan cameras	5D41111	LUT
8-camera	Up to eight 1-connection area-scan cameras	8D11111111	LUT

3603 Coaxlink Quad CXP-12

Firmware Variant	Description	Host Connections Map	Advanced Processing
1-camera	One 1- or 2- or 4-connection area-scan camera	1D4	LUT CFA
1-camera, line-scan	One 1- or 2- or 4-connection line-scan camera	1D4	LUT
4-camera	One or two or three or four 1-connection area-scan cameras	4D1111	LUT

3620 Coaxlink Quad CXP-12 JPEG

Firmware Variant	Description	Host Connections Map	Advanced Processing
4-camera	One or two or three or four 1-connection area-scan cameras	4D1111	CFA JPEG

3621-LH Coaxlink Mono CXP-12 LH

Firmware Variant	Description	Host Connections Map	Advanced Processing
1-camera	One 1-connection area-scan camera	1D1	LUT

3622 Coaxlink Duo CXP-12

Firmware Variant	Description	Host Connections Map	Advanced Processing
1-camera	One 1- or 2-connection area-scan camera	1D2	LUT
2-camera	One or two 1-connection area-scan cameras	2D11	LUT

2.3. CoaXPress Standard Compliance

Coaxlink products together with Coaxlink driver version 5.0 or higher complies with the following versions of the CoaXPress standard:

- CoaXPress Standard 1.0
- CoaXPress Standard 1.1
- CoaXPress Standard 1.1.1
- CoaXPress Standard 2.0 (Preliminary)

The following deviations to the CoaXPress standards apply:

- *For all versions:* Restrictions to the camera connection schemes.

See also: ["Host Connections Maps" on page 43.](#)

2.4. Supported Operating Systems

Windows

The Coaxlink driver is designed to support all Windows versions from 7 SP1 to 10, including the server versions, on x86 (32-bit) and x86_64 (64-bit) platforms.

This release has been validated with the following Windows versions:

OS Name & Version	Platform	Notes
Microsoft Windows 7	x86 (32-bit)	Service Pack 1 with the latest updates
Microsoft Windows 8.1	x86 (32-bit)	-
	x86-64 (64-bit)	
Microsoft Windows 10	x86-64 (64-bit)	Version 1903, a.k.a. May 2019 Update



NOTE

The Coaxlink driver for Windows 10 is signed by Microsoft.



NOTE

Power saving modes of the operating systems (StandBy, Sleep, Suspend...) are not supported.

Linux

The Coaxlink driver is designed to be distribution-independent on x86, x86_64, and aarch64 platforms. It is expected to work with a wide range of distributions.

This release has been validated with the following distribution(s):

OS Name & Version	Platform	Notes
Linux CentOS 7	x86 (32-bit)	Kernel version 3.10
Linux Ubuntu 14.04	x86 (32-bit)	Kernel version 3.13
Linux Ubuntu 14.04	x86-64 (64-bit)	Kernel version 3.13
Linux Ubuntu 16.04.1 LTS	aarch64 (64-bit)	Kernel version 4.4.0-57
Linux Ubuntu 17.04	x86_64 (64-bit)	Kernel version 4.10
Linux Ubuntu 18.04.1 LTS	x86_64 (64-bit)	Kernel version 4.18.7



NOTE

Power saving modes of the operating systems (StandBy, Sleep, Suspend...) are not supported.

macOS

The Coaxlink driver is designed to support all macOS versions from version 10.12 on x86_64 (64-bit) platforms.

This release has been validated with the following version(s):

OS Name & Version	Platform	Notes
macOS 10.12.6	x86-64 (64-bit)	A.k.a. Sierra
macOS 10.13.4	x86-64 (64-bit)	A.k.a. High Sierra

**NOTE**

The Coaxlink driver for macOS is signed by Euresys using a certificate that has been signed by Apple.

**NOTE**

Power saving modes of the operating systems (StandBy, Sleep, Suspend...) are not supported.

2.5. Memento

Memento version 4.0 or later is required when using Coaxlink driver version 4.0 or later.

Memento version 9.5 is required to use the Memento Analyzer.

2.6. Development Tools

The Coaxlink driver is supplied as GenICam GenTL producer libraries (coaxlink.cti):

- An x86 dynamic library designed to be used with ISO-compliant C/C++ compilers for the development of `x86` applications.
- An x86_64 dynamic library designed to be used with ISO-compliant C/C++ compilers for the development of `x86_64` applications.
- An aarch64 dynamic library designed to be used with ISO-compliant C/C++ compilers for the development of `aarch64` applications.
- A .NET assembly designed to be used with development environments compatible with .NET Framework 4.0 or higher.

The Coaxlink cards should be usable with any development tool that supports at least one of these interfaces.

2.7. Software Tools

Tool Name	Tool Description
Coaxlink Firmware Manager	Tool for installing or upgrading the firmware embedded on the Coaxlink cards.
GenICam Browser(64-bit)	64-bit version of the GUI tool giving access to all the GenICam features exposed by the GenTL Producer(s) in your system
GenICam Browser	32-bit version of the GenICam Browser
GenTL Console (64-bit)	64-bit version of the command-line tool giving access to all the functions and commands exposed by the Euresys GenTL Producer
GenTL Console	32-bit version of the GenTL Console

3. Important Notices



WARNING

Important notifications to be read before installing and/or using the product on your PC!

3.1. Firmware Version Requirements	19
3.2. CPU Requirements	20
3.3. Driver Installation on macOS	21
3.4. Driver Installation on Windows	22
3.5. Driver Installation on Windows 7	24
3.6. Driver Installation on Windows Server 2016	25
3.7. Flash EEPROM Change Note	26

3.1. Firmware Version Requirements



WARNING

Important notification to be read before installing and/or using the product on your PC!

Coaxlink 12.4

The following table lists, for each product/firmware variant combination, the *minimum firmware version number* required to use Coaxlink driver 12.4:

Product/Firmware Variant Combinations	Min. Firmware Version Number
All product/firmware variant combinations	319



WARNING

If the requirement is not satisfied for all the Coaxlink cards in your system, it is *mandatory* to apply the Firmware Upgrade procedure prior to using this version of the driver.



NOTE

The Coaxlink driver checks the compatibility of the firmware installed on every Coaxlink card. For Coaxlink cards having an incompatible firmware, the GenTL driver exposes 0 (zero) Device and the GenICam Browser displays a "Firmware too old" error message:

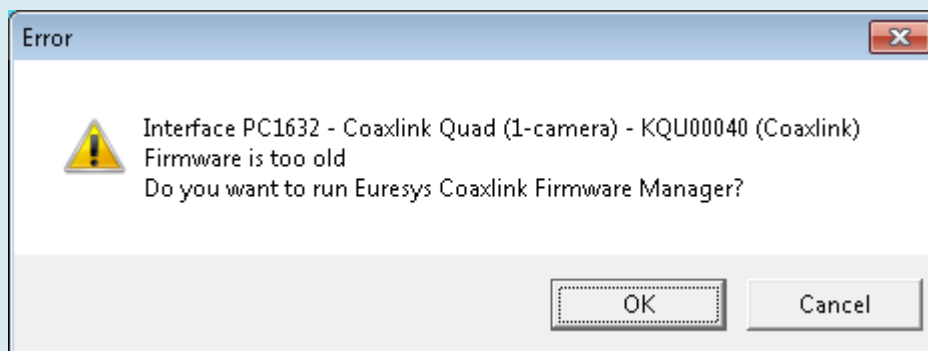

"Firmware too old" error message

3.2. CPU Requirements



WARNING

Important notification to be read before installing and/or using the product on your PC!

The image converter requires a CPU that has the Supplemental Streaming SIMD Extension 3 (SSSE3) instruction set.

3.3. Driver Installation on macOS



WARNING

Important notifications to be read before installing the driver on your macOS PC!

Memento and Coaxlink Installers

This notice applies when installing Coaxlink or Memento Euresys drivers on macOS

After Memento and Coaxlink package files have been downloaded with *Safari*, the usual *double-click* to launch the installer will not let you install the package.

You shall use instead *control+click* and select *Open* to launch the installer. A window will pop up, click then on *Open* to proceed.

macOS High Sierra or later

This notice applies when installing Coaxlink or Memento Euresys drivers on macOS High Sierra or later

Starting with macOS High Sierra, the user has to manually approve loading of third-party kernel extensions.

See also: https://developer.apple.com/library/content/technotes/tn2459/_index.html

The first time Memento and Coaxlink drivers are installed, their kernel extensions have to be approved.

A window about blocked extensions might pop up during the package installation.

Go to *Preferences* → *Security & Privacy* and ensure that *System software from developer "Euresys SA" was blocked from loading.* is not displayed. If so, click on **Allow**.

3.4. Driver Installation on Windows



WARNING

Important notification to be read before installing the driver on your Windows PC!

The following Windows Security warning messages may occur at driver installation on Microsoft Windows:

Always trust Euresys code-signing certificate

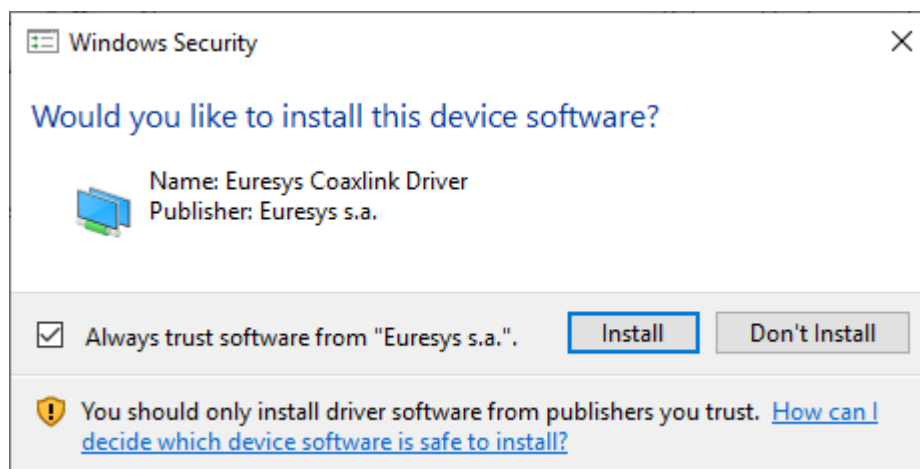

This Windows security warning occurs when the Euresys code-signing certificate is missing from the "Trusted Publishers" Windows Certificate store. This happens, for instance, when the Euresys code-signing certificate must be renewed.

Follow the instructions to install the current Euresys code-signing certificate into the "Trusted Publishers" Windows certificate store.

Missing time-stamping certificate

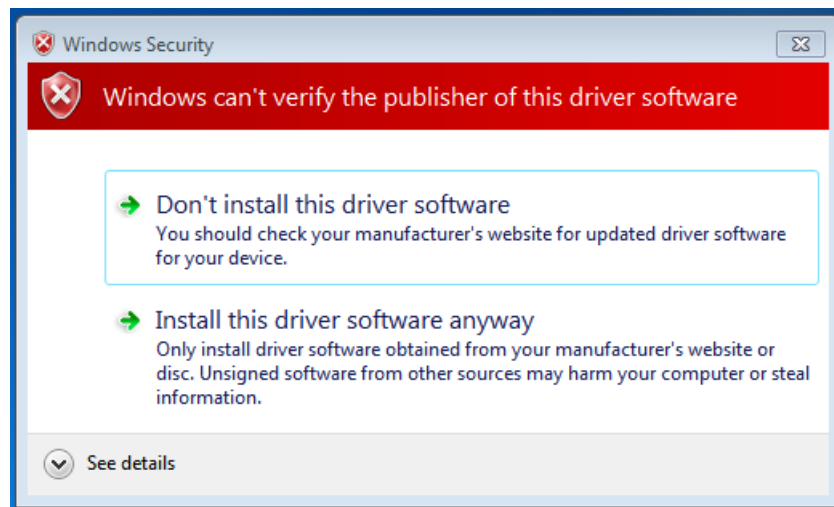

This Windows security warning occurs when the VeriSign Universal Root CA certificate for time-stamping is missing from the Windows certificate store.

This issue can be solved by installing this missing certificate, which is available in an archive that can be downloaded [here](#), on the Symantec website.

3.5. Driver Installation on Windows 7

**WARNING**

Important notification to be read before installing Euresys drivers on your Windows 7 PC!

Renewal of the "Code Signing For Microsoft Authenticode" certificate for Euresys drivers and SHA-256 support

Microsoft Windows 7 and Microsoft Windows Server 2008 R2 now require at least SP1 as well as some specific Windows updates in order to support SHA-256 certificates.

The following Windows update is required and must be installed before using Euresys drivers on Microsoft Windows 7 and Microsoft Windows Server 2008 R2:

- [KB3033929](#) (provides support for SHA-256 certificates which are required by Microsoft): without this one, a “Windows cannot verify the digital signature for the drivers required for this device” (code 52) error will prevent the Euresys drivers from loading.

3.6. Driver Installation on Windows Server 2016



WARNING

Important notification to be read before installing Euresys drivers on your Windows Server 2016 PC!

This notice applies to :

- Coaxlink driver since version 4.7

When installing Euresys drivers on a fresh install of Windows Server 2016, the UEFI Secure Boot feature must be disabled in BIOS so that the Euresys drivers can be loaded by Windows when Secure Boot is enabled.

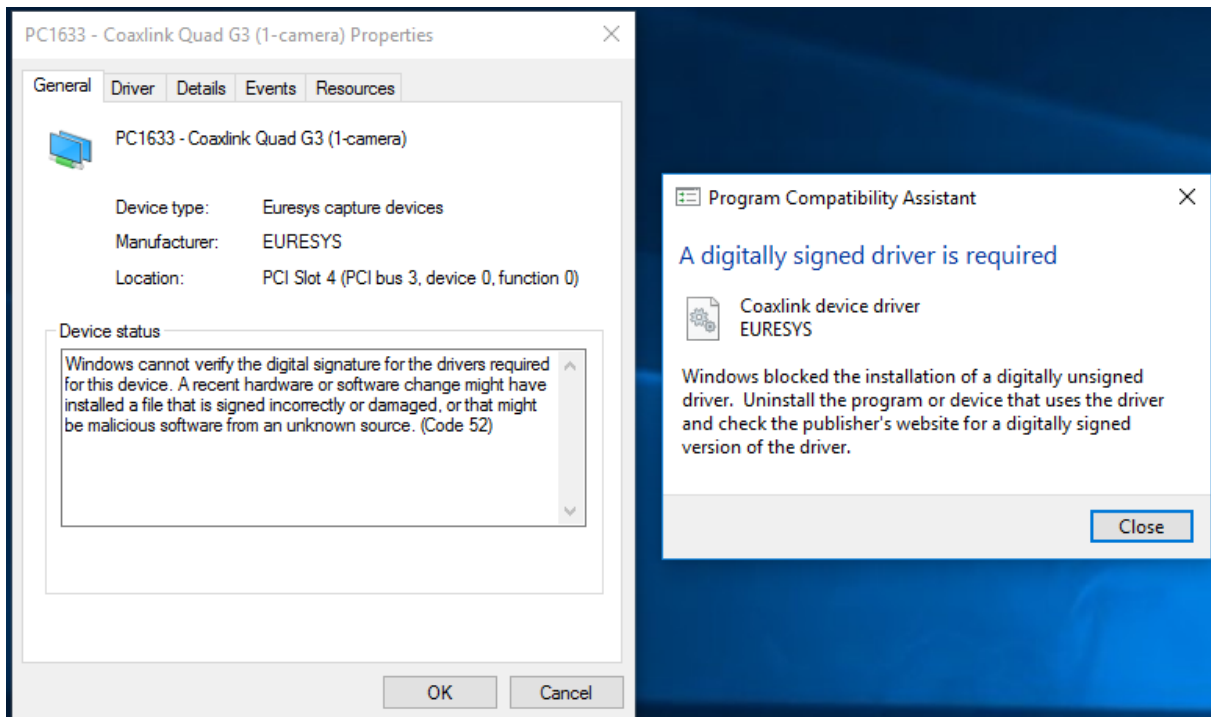

Device Manager error message

3.7. Flash EEPROM Change Note



WARNING

Important notification to be read before installing and/or using the product on your PC!

Several Coaxlink products will undergo a hardware change of the Flash EEPROM control logic.



NOTE

The Flash EEPROM is the memory that stores the contents of the Coaxlink's on-board FPGA.

Affected products list

Product	S/N Prefix	First Serial Number of New Cards
1629 Coaxlink Duo PCIe/104-EMB	KDI	10,000
1633 Coaxlink Quad G3	KQG	10,000
1633-LH Coaxlink Quad G3 LH	KQH	10,000
1634 Coaxlink Duo PCIe/104-MIL	KDR	10,000
1635 Coaxlink Quad G3 DF	KDF	10,000
1637 Coaxlink Quad 3D-LLE	KQE	10,000

Consequences

Existing applications using a Coaxlink driver prior to version 10.0.0 are required to use a new procedure to install or update the firmware on new boards.

The change has no impact for applications already using Coaxlink driver 10.0.0 or higher.

With the exception of the firmware update, the change has strictly no impact on the product functionality, performance and specifications:

- The hardware design of these new cards, including the CoaXPress interface, PCI Express interface, the FPGA and the I/O, has not been changed.
- The functionality, performance and specification of the new cards is guaranteed to remain unchanged. Once programmed with the corresponding firmware, the new cards remain compatible with all previous versions of the Coaxlink driver.



TIP

For further information, read the *D207EN-Flash EEPROM Change Note PDF* document on the PDF Guides page.



NOTE

Coaxlink related PDF documents are available online at the following URL:
https://documentation.euresys.com/Products/Coaxlink/Coaxlink/en-us/Content/00_Home/PDF_Guides.htm.

4. Release Details

4.1. Products Support Changes	29
4.2. Firmware Variants Support Changes	30
4.3. Added/Improved Features	31
4.4. Breaking Changes	33

4.1. Products Support Changes

Coaxlink 12.4

Added Products

3621-LH Coaxlink Mono CXP-12 LH

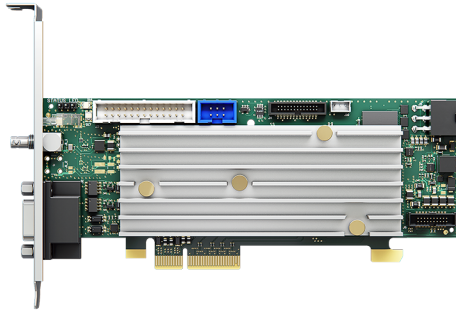

A PCIe 3.0 one-connection CoaXPress CXP-12 frame grabber.

The large passive heatsink provides an efficient thermal interface while meeting the board-to-board space requirements for single slot.

3622 Coaxlink Duo CXP-12

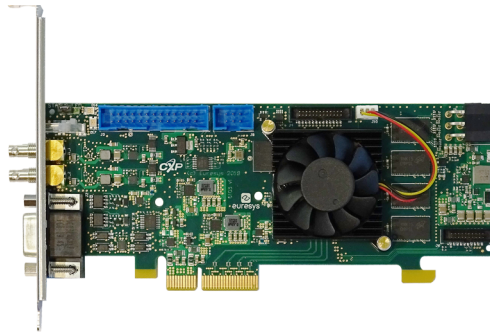

A PCIe 3.0 two-connection CoaXPress CXP-12 frame grabber.

4.2. Firmware Variants Support Changes

Coaxlink 12.4

Added firmware variants

Target Product	Firmware Name	Description
3621-LH Coaxlink Mono CXP-12 LH	1-camera	One 1-connection area-scan camera <ul style="list-style-type: none">• Host Connections Map: 1D1• Advanced processing: LUT
3622 Coaxlink Duo CXP-12	1-camera	One 1- or 2-connection area-scan camera <ul style="list-style-type: none">• Host Connections Map: 1D2• Advanced processing: LUT
	2-camera	One or two 1-connection area-scan cameras <ul style="list-style-type: none">• Host Connections Map: 2D11• Advanced processing: LUT

4.3. Added/Improved Features

Coaxlink 12.4

CoaXPress host interface

CoaXPress 2.0 error counters

Added a set of counters to keep track of errors that the CoaXPress protocol can detect on each individual CoaXPress connection. Namely:

- Connection lock loss
- 8b/10b encoding error
- Duplicated characters mismatch that could be corrected
- Duplicated characters mismatch that could NOT be corrected
- CRC error in data packets
- CRC error in control packets
- CRC error in event packets

Added new **CoaXPressErrorCounters** parameters category and new parameters to GenICam Interface module:

CxpLinkLockLossCount and **CxpLinkLockLossCountReset**
Cxp8b10bErrorCount and **Cxp8b10bErrorCountReset**
CxpDuplicatedCharactersUncorrectedErrorCount and
CxpDuplicatedCharactersUncorrectedErrorCountReset
CxpDuplicatedCharactersCorrectedErrorCount and
CxpDuplicatedCharactersCorrectedErrorCountReset
CxpStreamDataPacketCrcErrorCount and **CxpStreamDataPacketCrcErrorCountReset**
CxpControlPacketCrcErrorCount and **CxpControlPacketCrcErrorCountReset**
CxpEventPacketCrcErrorCount and **CxpEventPacketCrcErrorCountReset**

See also: [CoaXPress 2.0 Error Counters](#) topic in the Coaxlink Functional Guide.

Discovery

Show IDs of discovered/missing extensions in memento traces at the end of the discovery procedure.

gentl.exe

PCI Express performance evaluation tool

Added `dtr` command to measure the data transfer rate from the Coaxlink on-board frame store to system memory.

See also: [PCIe Data Transfer Rate Test Program](#) topic in the Coaxlink Functional Guide.

4.4. Breaking Changes

**WARNING**

Changes in the API that are not backward compatible.

Since Coaxlink 12.2

New default value of `CxpLinkConfigurationOption`

`NeverWrite` is the new default value of `CxpLinkConfigurationOption`.

**NOTE**

The recommended way to set the CoaXPress link configuration is by using the equivalent feature in the remote device module; this can be named `ConnectionConfig`, `LinkConfig`, or `CxpLinkConfiguration` depending on the camera.

**WARNING**

Alternatively, the previous behavior can be restored by setting `CxpLinkConfigurationOption` to `AlwaysWrite`. However, the GenApi cache for this register might become invalid!

Since Coaxlink 12.0

Quad3DLLL

`STREAM_INFO_CUSTOM_WIDTH` and `BUFFER_INFO_WIDTH` are now multiplied by two if two laser-lines are extracted

.NET Framework compatibility

The Coaxlink .NET assembly targets:

- the .NET framework 2.0 in Coaxlink versions up to 11.x
- the .NET framework 4.0 in Coaxlink versions 12.0 and higher

Since Coaxlink 11.1

Quad3DLL Behavior of 1637 Coaxlink Quad 3D-LLE from firmware revision 285.

The line pitch alignment has been changed to 16 bytes (before firmware revision 285, the line pitch alignment of the card was 8 bytes); this means the `Width` of the camera must be a multiple of 16 (`Mono8`).

When the extraction is disabled, the card behaves like an area-scan variant (and the data stream feature `BufferHeight` is not available); when the extraction is enabled, `BufferHeight` is available and determines the number of profiles to extract; when the extraction is disabled, applications no longer require extra care to make sure acquisitions always start with the first line of the acquired images.

CoaXPress

Ignore any remote device whose master connection is not connected to the first connector of a Coaxlink Device; the driver now requires a master connection to be connected to the first connector whereas the extension connections can be connected to the remaining Coaxlink Device connectors in any order.

See also: "Firmware Variants per Product" on page 8 and "Host Connections Maps" on page 43 for the applicable connection schemes.

Updated `ImageConvertInput` and `ImageConvertOutput` structures

Subsequent potential build issues can be fixed by either:

- using `IMAGE_CONVERT_INPUT` and `IMAGE_CONVERT_OUTPUT` initialization macros (recommended approach) or
- adding the suffix `Version0` to `ImageConvertInput` and `ImageConvertOutput` types



NOTE

Users of EGrabber are not affected by this breaking change

Since Coaxlink 10.3

PayLoadSize Behavior

The feature `PayLoadSize` is not available anymore when the remote device `Width` is not in line with the data stream `Width.Inc`

Since Coaxlink 10.2

Additional constructor parameter required

The grabber classes (based on EGrabber) instantiated by EGrabbers require the additional constructor parameter (`bool remoteRequired`).

See also: sample "213-egrabbers" for details

Since Coaxlink 10

Deprecated functions from namespace Euresys

Deprecated the functions `Features`, `RegexFeatures`, `GlobFeatures`, `EnumEntries`, `RegexEnumEntries`, `GlobEnumEntries` from namespace `Euresys`, which are still available by `#defining EURESYS_USE_NS_EURESYS_DEPRECATED_API`.



TIP Two options to fix user code:

- *Recommended change* Replace all occurrences of:

- `Euresys::Features()` by `Euresys::query::features()`
- `Euresys::RegexFeatures(re)` by `Euresys::query::features().regex(re)`
- `Euresys::GlobFeatures(g)` by `Euresys::query::features().glob(g)`
- `Euresys::EnumEntries(f)` by `Euresys::query::enumEntries(f)`
- `Euresys::RegexEnumEntries(f, re)` by `Euresys::query::enumEntries(f).regex(re)`
- `Euresys::GlobEnumEntries(f, g)` by `Euresys::query::enumEntries(f).glob(g)`

- Or add `#define EURESYS_USE_NS_EURESYS_DEPRECATED_API` before `#include <EGrabber.h>` (or `#include <EGenTL.h>`), a quick fix that doesn't require changing source code.

Since Coaxlink 9.3.1

Removed data stream event counts from the list of possible contexts of device event notifications

Removed data stream event counts from the list of possible contexts of device event notifications.

`StartOfCameraReadoutEventCount`, `EndOfCameraReadoutEventCount`, `StartOfScanEventCount`, `EndOfScanEventCount`, `RejectedFrameEventCount`, and `RejectedScanEventCount` are no longer valid values for `EventNotificationContext1`, `EventNotificationContext2`, and `EventNotificationContext3` in the device module.

Since Coaxlink 9.3

Reset of `StartOfScanTriggerSource`, `EndOfScanTriggerSource` and `ScanLength` features

Data stream features `StartOfScanTriggerSource`, `EndOfScanTriggerSource` and `ScanLength` are now reset by the data stream feature `StreamReset`. Previously, they were reset by the device feature `DeviceReset`.

Since Coaxlink 9.2

GenAPI Features Range Checking

Range checking will prevent applications from setting forbidden values to camera features. A meaningful error will be reported if such an event should happen.

Since Coaxlink 9.1.1

Camera Model - Exposure Time Range Boundaries

When `ExposureTimeMin` and/or `ExposureTimeMax` are/is set, the order in which the features `ExposureTimeMin`, `ExposureTimeMax` and `ExposureTime` are set is imposed by the constraints.

Since Coaxlink 7.1.1

GenTL 1.5 Header File

Moved to standard GenTL 1.5 header file (was previously GenTL 1.4):

- GenTL 1.5 changed namespace from `GenICam::Client` to `GenTL`,
- Coaxlink custom GenTL definitions have been moved accordingly from the namespace `GenICam::Client::Euresys` to namespace `GenTL::EuresysCustomGenTL`,
- replaced header file `GenTL_v1_4.h` by `GenTL_v1_5.h`,
- replaced header file `GenTL_v1_4_EuresysCustom.h` by `GenTL_v1_5_EuresysCustom.h`.

Euresys::GenTL Class Renaming

Renamed the class `Euresys::GenTL` into `Euresys::EGenTL` to avoid name conflicts with the new standard GenTL 1.5 namespace `GenTL`. This will impact any code using the class `Euresys::GenTL`:

- renamed header file `EuresysGenTL.h` into `EGenTL.h`,
- renamed header file `EuresysGenTLErrors.h` into `EGenTLErrors.h`,
- `Euresys::EGenTL` is now declared in header file `EGenTL.h`.

Deprecated Euresys::SharedGenTL Class

Deprecated the class `Euresys::SharedGenTL`, which is still available by defining `EURESYS_USE_SHAREDGENTL_DEPRECATED_API`.



TIP

Two options to fix user code:

- *Recommended change* Replace all occurrences of `Euresys::SharedGenTL` by `Euresys::EGenTL`,
- Or add `#define EURESYS_USE_SHAREDGENTL_DEPRECATED_API` before `#include <EGrabber.h>`, a quick fix that doesn't require changing source code.

GenTL 1.5 Changes

Announcing or revoking buffers while acquiring returns the error code `GC_ERR_BUSY` (was `GC_ERR_RESOURCE_IN_USE` for GenTL 1.4)

Revoking a queued buffer returns the error code `GC_ERR_BUSY` (was `GC_ERR_RESOURCE_IN_USE` for GenTL 1.4)

New device access status values (defined by GenTL 1.5) returned by the GenTL functions `IFGetDeviceInfo` and `DevGetInfo` for the command `DEVICE_INFO_ACCESS_STATUS`:

GenTL 1.5 Changes

- `DEVICE_ACCESS_STATUS_OPEN_READWRITE`: when the device is opened by the current producer with read/write access
- `DEVICE_ACCESS_STATUS_OPEN_READONLY`: when the device is opened by the current producer with read-only access

Since Coaxlink 7.0.0

OemSafetyKey Length

The length of `ProgramOemSafetyKey` and `CheckOemSafetyKey` is now limited by a user-configurable `MaximumOemKeyLength` (4096 characters by default)

LUT Configuration Locking

LUT configuration features (datastream) are locked while grabbing.

CIC Features Availability

Features related to the CIC (device) are not available when `CameraControlMethod` is `NC` or `EXTERNAL`.

Since Coaxlink 4.6.1

EGrabber API

Deprecated EGrabber method `announceBuffer` (superseded by `announceAndQueue`).

Two options to fix user code:

**TIP**

Recommended change Replace all occurrences of `announceBuffer` by `announceAndQueue (GenTLMemory (...))` or `announceAndQueue (UserMemory (...))`,

**TIP**

Or add `#define EURESYS_USE_EGRABBER_DEPRECATED_API` before `#include <EGrabber.h>`.

Since Coaxlink 4.5.1

Euresys Name Space for EGrabber Classes

EGrabber C++ classes now belong to `Euresys` namespace.

Two options to fix user code:

**TIP**

Recommended change Replace each occurrence of `EGrabber` by `Euresys::EGrabber`,

**TIP**

Or add `using namespace Euresys;` after `#include <EGrabber.h>`.

Since Coaxlink 4.4.1

EGrabber API

The API of `EGrabber` .NET classes have changed since Coaxlink 4.4.0 beta

`GenTL` class now behaves like `SharedGenTL`, which is what most users need

- The `GenTL` constructor accepts a new argument, named `shared`, which can be used to revert to the old behavior.

RGBConverter.h

Added `inplace1x2yeReordering` methods instead of `Inplace1x2yeReordering` class

- User code needs to be adapted to call `inplace1x2yeReordering` instead of creating an `Inplace1x2yeReordering` instance, please see `include/RGBConverter.h` for a code sample.

Since Coaxlink 4.4.0

.NET Assembly

Added new assembly exposing `EGrabber` classes, previous `CoaxlinkGrabber` classes are removed from the assembly.

EGrabber

Deprecated `getInfoString` methods (replaced by `getInfo`).

Two options to fix user code:

**TIP**

Recommended change Replace all occurrences of `getInfoString<module>` (and `getBufferInfoString`) by `getInfo<module, std::string>` (and `getBufferInfo<std::string>`)

**TIP**

Or add `#define EURESYS_USE_EGRABBER_DEPRECATED_API` before `#include <EGrabber.h>`.

GenTL C++ class

Deprecated `bayerConvert`

Though the function `bayerConvert` is superseded by the image converter, it is still possible to use it, if required please add `#define EURESYS_USE_BAYER_DEPRECATED_API` before `#include <EuresysGenTL.h>` or `#include <EGrabber.h>`

Since Coaxlink 4.3

Data Stream Module GenICam Feature

`UnpackingMode`: Changed default value to LSB (instead of MSB)

Since Coaxlink 4.1

Device Module Features

Merged `CycleTriggerSource` and `CycleHardwareTriggerSource` features.

Renamed `CycleSoftwareTrigger` into `StartCycle`.

Renamed `CyclePeriodTarget` into `CycleMinimumPeriod`.

Renamed `ErrorCounter` into `ErrorCount`.

Renamed `ErrorCounterReset` into `ErrorCountReset`.

Removed backward compatibility for deprecated features: `TriggerSource`, `TargetFramePeriod`, `ExposureRecovery`.

5. Known Issues

5.1. Deviations from the CoaXPress specification	43
Host Connections Maps	43
5.2. Deviations from the GenTL specification	50
5.3. Deviations from the PCIe 3.0 specification	52
5.4. Functional Limitations	53
aarch64 ARM Processor Architecture	53

5.1. Deviations from the CoaXPress specification

Host Connections Maps43

Host Connections Maps

The CoaXPress standard suggests that Devices (cameras or data forwarding devices) can be connected to the Host (frame grabber) using a free connection scheme. Instead, the Host Interface of Coaxlink requires a specific assignment of the Device connections to the Host connectors. Such assignment is named *Host Connections Map*.

The Host Connections Map is hard-coded in the product firmware variant.



WARNING

The Coaxlink product and firmware variant must be selected according to the required mapping!

Host Connections Map naming convention

The *Host Connections Map* or *HCMAP* designates how the connections of the Host Interface of a Coaxlink card are allocated to the Devices (cameras).

A Host Connection Map - HCMAP - is designated by an acronym using the following Euresys proprietary naming convention:

$$\langle dev\#\rangle\langle dev\text{-}type\rangle[\langle str\#\rangle S]\{\langle con\#\rangle \dots \langle con\#\rangle\}[\langle SL\text{-}con\#\rangle]$$

where:

- $\langle dev\#\rangle$ declares the maximum number of Devices (cameras) that can be attached to the Host Interface.
 - 1 for a single-device Host interface
 - 2 for a 2-device Host interface
 - ...
- $\langle dev\text{-}type\rangle$ declares the device type.
 - D for standard CoaXPress devices
 - DF for virtual devices used in the Data Forwarding schemes
- $\langle con\#\rangle$ declares the number of connections available for each device.
 - 1 for a single-connection device

- 2 for 2-connection device
 - ...
This field is repeated once for each device.
- <str#>S declares the maximum number of data streams allowed by a device.
 - This field is omitted when there is only 1 stream
 - 4S for a up to 4 data-streams per device
- SL<-con#> declares the number connections per sub-link.
 - SL4 for a 4-connection sub-links
This field is omitted when there are no sub-links.

Examples

HCMAP 2D22 designates a Host Interface with 2 standard 1-data-stream CoaXPress Devices and 2 connections for each device.

HCMAP 1D4S4 designates a Host Interface with 1 standard CoaXPress Devices, up to 4 data streams, and 4 connections per device.

1D1 host connections map

One 1-connection device



1D2 host connections map

One 1- or 2-connection device



1D4 host connections map

One 1- or 2- or 4-connection device

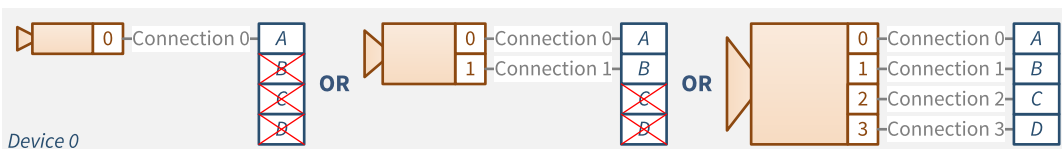

1D8 host connections map

One 1- or 2- or 4- or 8-connection device

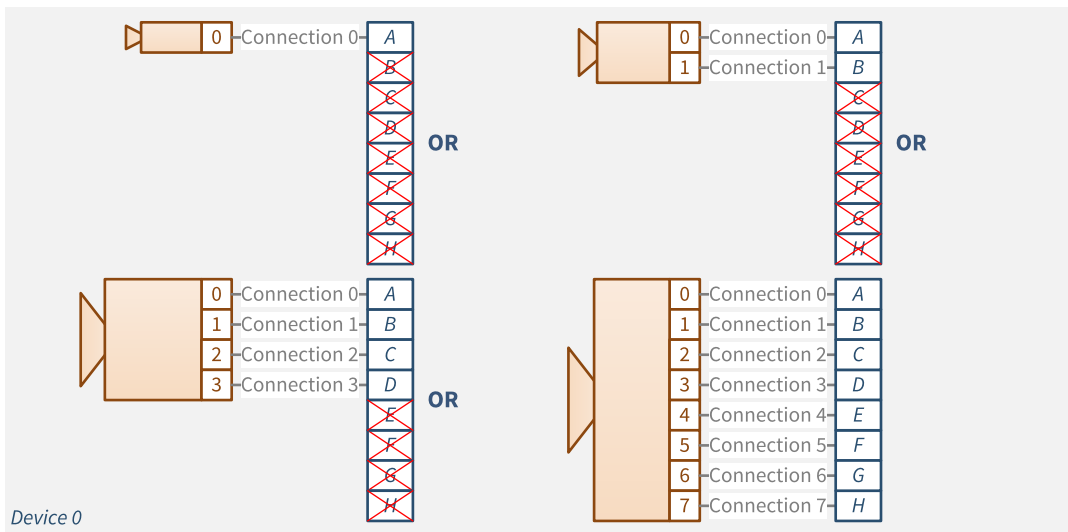

1D4S4 host connections map

One 1- or 2- or 4-connection device, up to 4 data streams

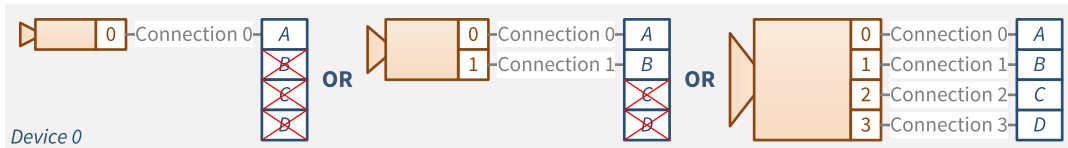

1D8SLM4 host connections map

Master 4-connection sub-link of an 8-connection device

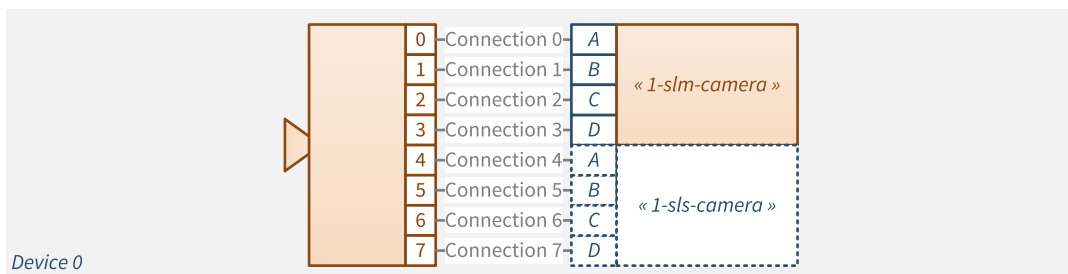

See also: [8-connection CoaXPRESS Cameras](#) for the connection scheme of an 8-connection camera to two Coaxlink cards.

1D8SLS4 host connections map

Slave 4-connection sub-link of an 8-connection device

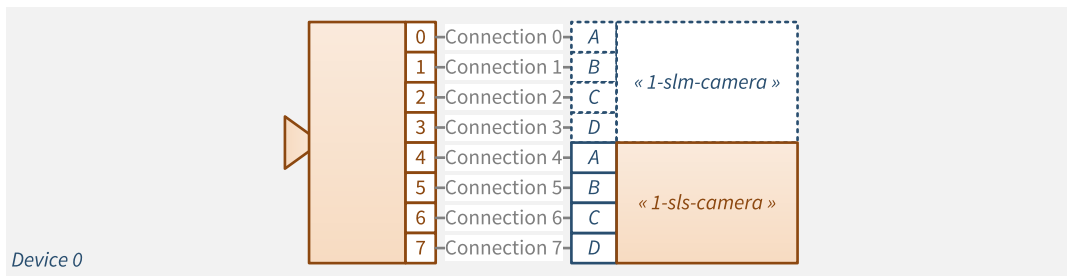

See also: 8-connection CoaXPress Cameras for the connection scheme of an 8-connection camera to two Coaxlink cards.

1DF4 host connections map

One 1- or 2- or 4-connection device

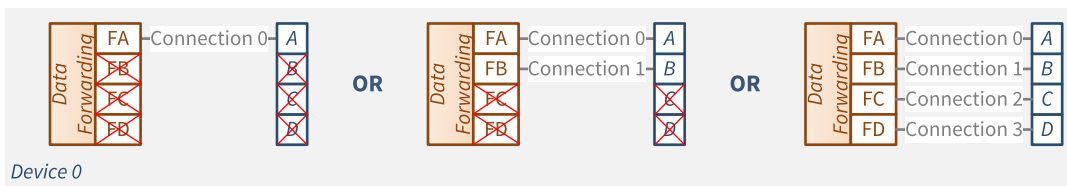

See also: CoaXPress Data Forwarding for the connection schemes of slave Data Forwarding devices.

2D11 host connections map

One or two 1-connection devices

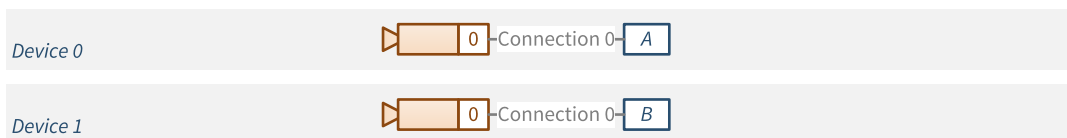

2D22 host connections map

One or two 1- or 2-connection devices

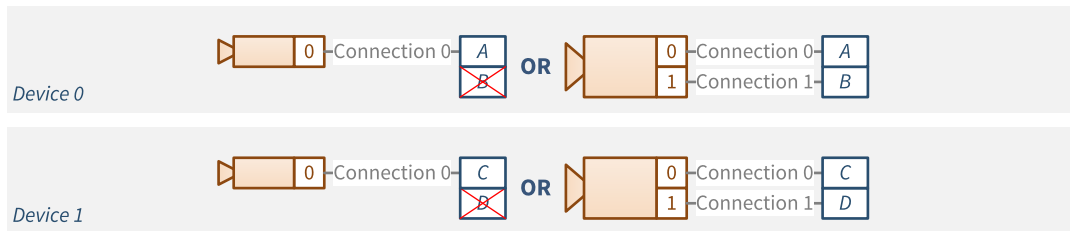

2D44 host connections map

One or two 1- or 2- or 4-connection devices

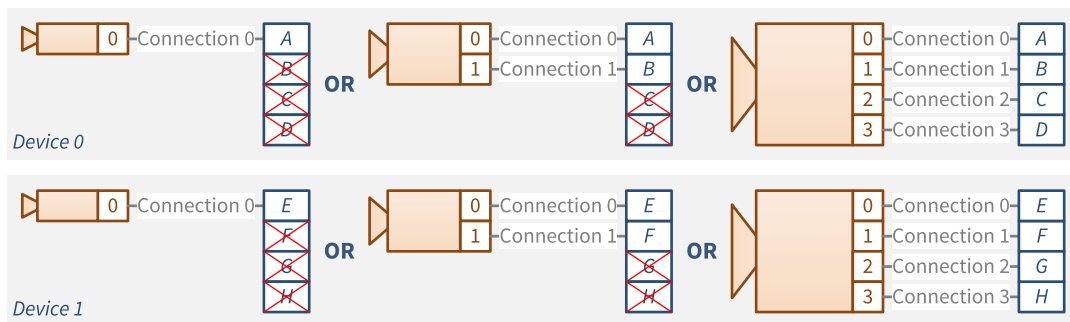

3D211 host connections map

One 1- or 2-connection and one or two 1-connection devices

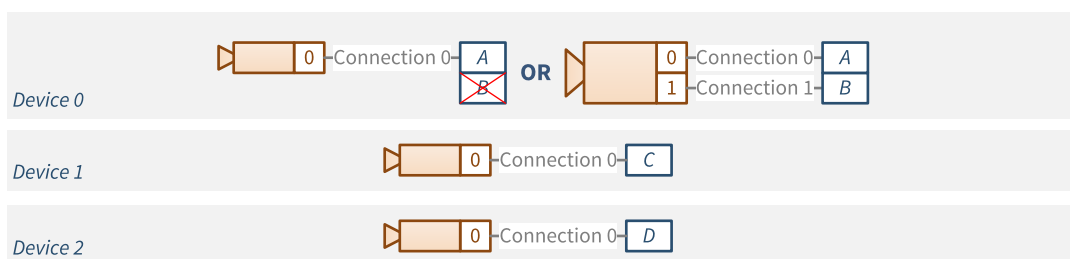

4D1111 host connections map

One or two or three or four 1-connection devices

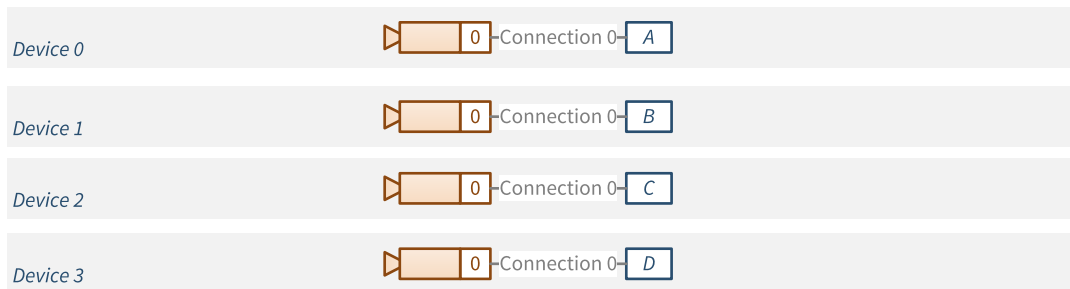

4D2222 host connections map

One or two or three or four 1- or 2-connection devices

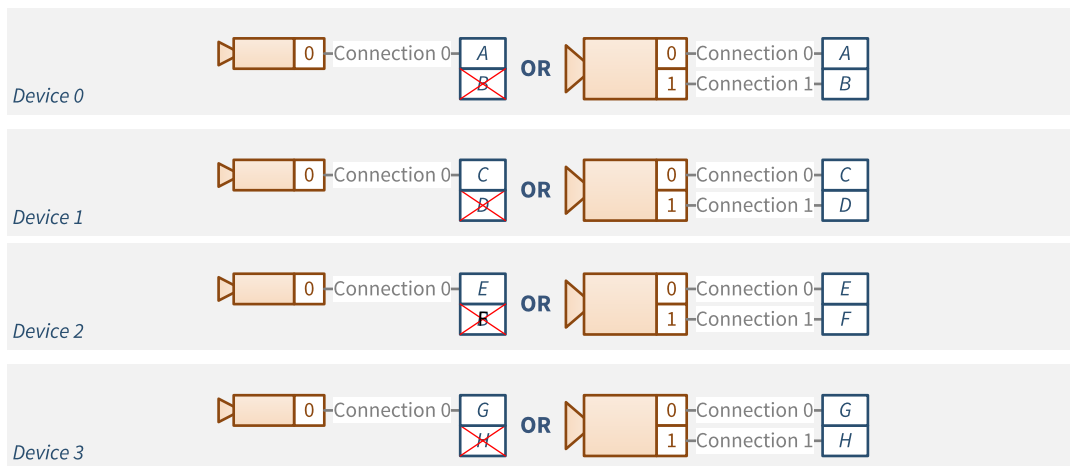

5D41111 host connections map

One 1- or 2- or 4-connection and one or two or three or four 1-connection devices

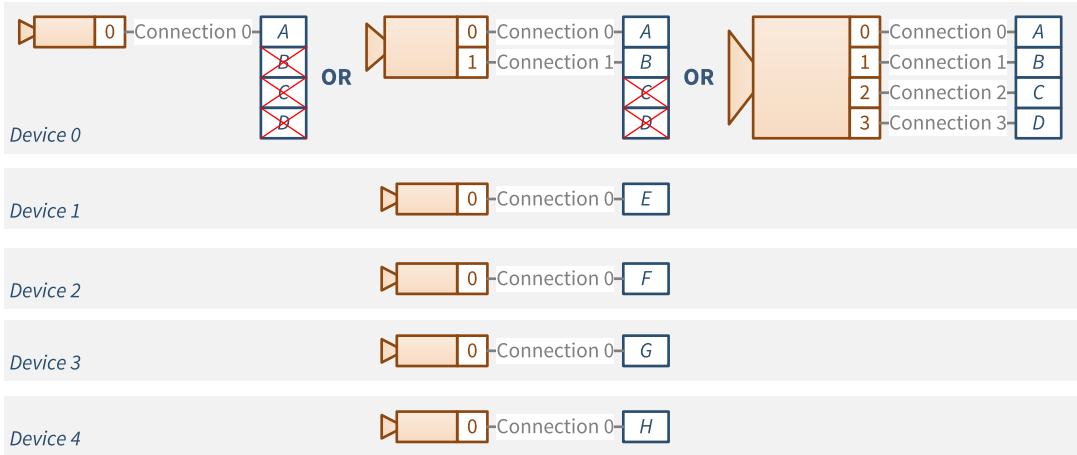

8D1111111 host connections map

Up to eight 1-connection devices

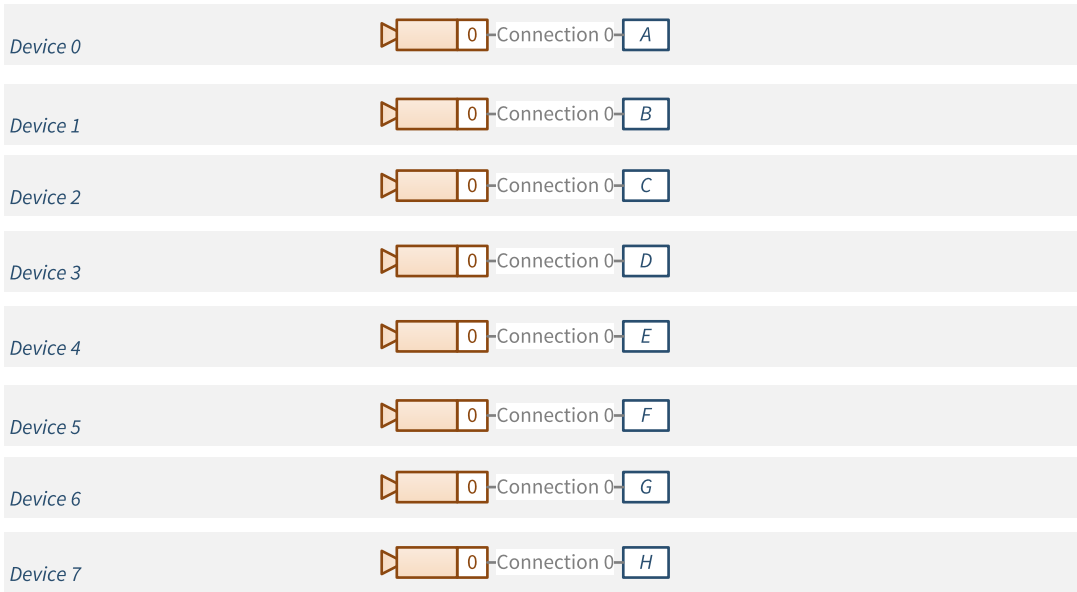

5.2. Deviations from the GenTL specification

EventKill

The GenTL specification states that:

- In case of multiple pending wait operations `EventKill` causes one wait operation to return with a `GC_ERR_ABORT` error code.
- This means that if more than one thread waits for an event, the `EventKill` function terminates only one wait operation and other threads will continue execution.
- Therefore in order to cancel all pending wait operations `EventKill` must be called as many times as wait operations are pending.
- In case this function is called while no wait operation was pending the next call to `EventGetData` will return a `GC_ERR_ABORT`.

This specification is nothing but the behavior description of a particular implementation based on a Windows auto-reset event.

This implementation is prone to race conditions: calling `EventKill` N times in a row to kill exactly N waiting threads is not guaranteed to work as expected because signaling an event that is already in the signaled state has no effect. In other words, some of the `EventKill` calls could have no effect.

`EventKill` as specified is not easy to use: How many `EventKill` calls are required? How many `EventGetData` calls should we expect to return `GC_ERR_ABORT`? Note that race conditions affect these questions.

The Euresys GenTL implementation solves these issues, but differs slightly:

- `EventKill` aborts all pending wait operations on the event handle.
- `EventKill` has no impact on subsequent wait operations.

DSStopAcquisition

The GenTL specification states that:

- Each call to `DSStartAcquisition` must be accompanied by a call to `DSStopAcquisition`.
- Argument `iNumToAcquire` passed to `DSStartAcquisition` sets the number of filled/delivered buffers after which the acquisition engine stops automatically.
- There must be a call to `DSStopAcquisition` accompanying each call to `DSStartAcquisition` even though the stream already stopped because the number of frames to acquire was reached.
- `DSStopAcquisition` returns `GC_ERR_RESOURCE_IN_USE` when the acquisition engine has already been terminated or has not been started.

The reasons for this behavior is not clear.

The Euresys GenTL implementation differs slightly:

- `DSStopAcquisition` will not return `GC_ERR_RESOURCE_IN_USE` if the data stream hasn't been started.
- `DSStopAcquisition` will not return `GC_ERR_RESOURCE_IN_USE` if the data stream has already been stopped by a prior call to `DSStopAcquisition`.
- `DSStopAcquisition` will not return `GC_ERR_RESOURCE_IN_USE` if the data stream has stopped automatically after `iNumToAcquire` images have been captured.

In other words, `DSStopAcquisition` is idempotent.

With the Euresys implementation, it is not necessary to treat some errors as normal, and race conditions (between `DSStopAcquisition` and the automatic stop of the data stream) are avoided. Furthermore, if the data stream has stopped automatically after acquiring `iNumToAcquire` images, `DSStartAcquisition` can be called without first calling `DSStopAcquisition`.

5.3. Deviations from the PCIe 3.0 specification

Applies to:

QuadG3

QuadG3LH

QuadG3DF

1633 Coaxlink Quad G3, 1633-LH Coaxlink Quad G3 LH and 1635 Coaxlink Quad G3 DF operate only at PCIe 2.0 and PCIe 3.0 link speeds.

These products cannot be used when inserted in PCIe revision 1.x slots.

5.4. Functional Limitations

aarch64 ARM Processor Architecture53

aarch64 ARM Processor Architecture

Image converters

The image conversion functions for the `aarch64` ARM processor architecture don't use the ARM NEON general-purpose SIMD engine.